



Aie ca coupe

Les trancheuses

 A white, upright guillotine slicer with a red blade. The blade has the text 'Slicer' and 'LUCY CLAY TOOLS' on it. The base is white and has 'LUCY CLAY TOOLS' printed on it. The background is a plain grey.	Lucy Clay : La guillotine	
 A white, compact, handheld slicer. It has a grid pattern on the top surface. The blade is visible and has 'LUCY CLAY TOOLS' printed on it. The background is white.	Lucy Clay : la trancheuse mini	

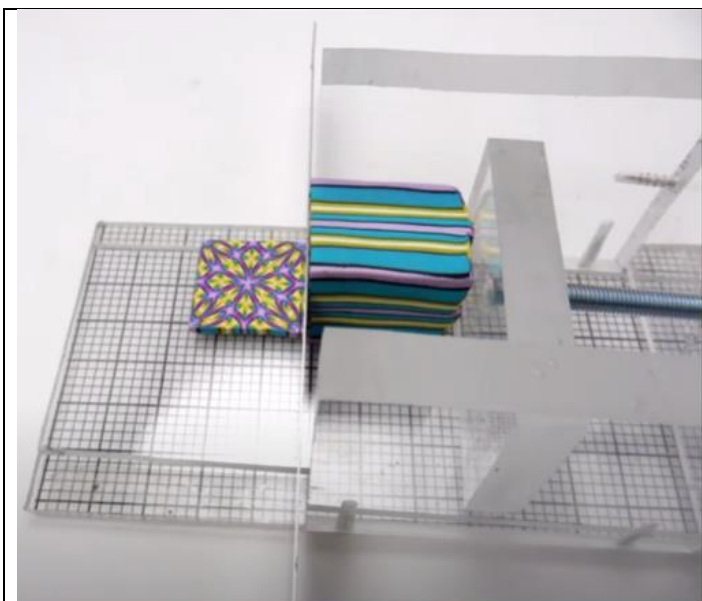

Le modèle d'Olga
Nicolas

[TUTORIEL trancheuse
de pâte polymère -
YouTube](#)

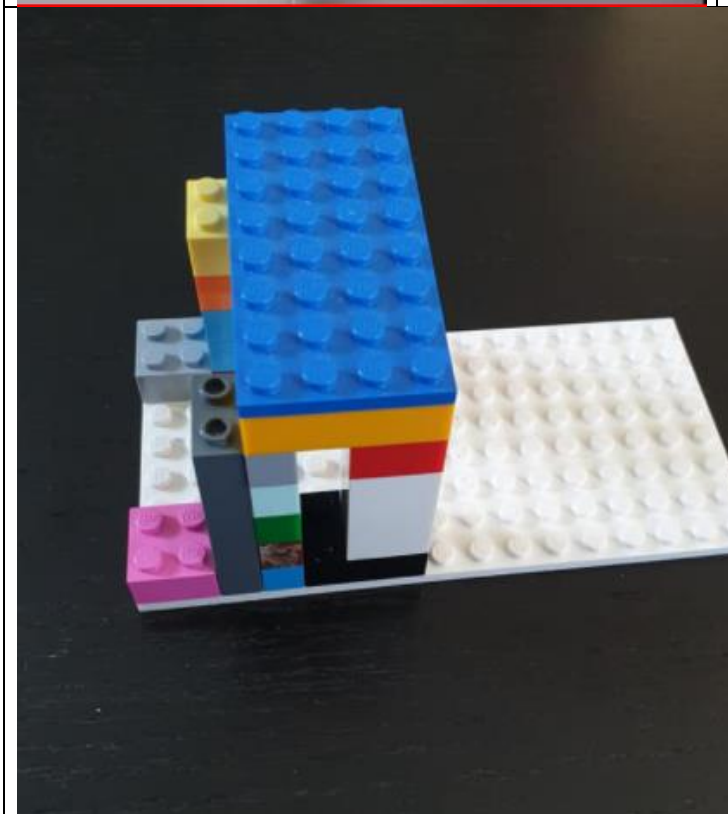

Le modèle Légo

https://www.facebook.com/permalink.php?story_fbid=3330885406973977&id=382804141782133

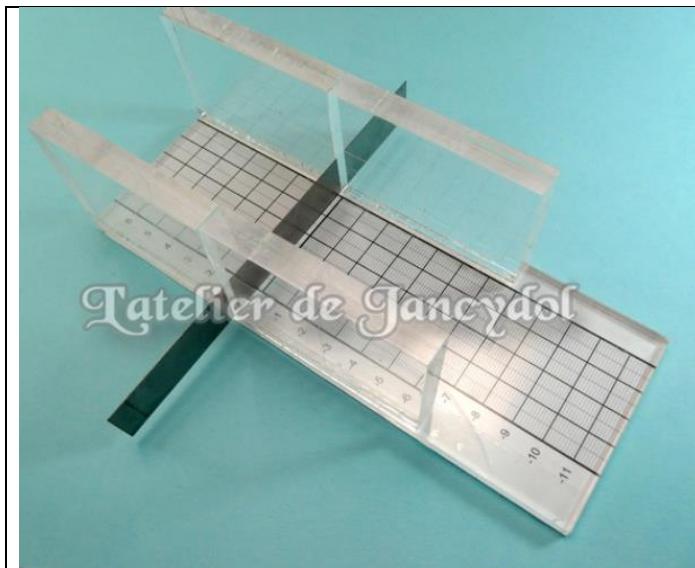

Le modèle de Genevieve

<http://paroledepate.canalblog.com/archives/2014/06/17/30091212.html>

Les lames

Les « sets de lames »





Fimo



 <p>CERNiT ACCESSOIRES</p> <p>3 LAMES BLADES KLÄMMEN LAME CUCHILLAS</p> <p>LÄMMER AMMET H-VERZIEGEL FICHERS RICKELAR BLAD</p>	<p>Cernit</p>	
---	---------------	--

 <p>Sculpey Tools</p> <p>CLAY BLADES LAMES POUR ARGILE CUCHILLAS PARA CORTAR ARCILLA</p> <p>3 pc pz</p>	<p>Sculpey</p>	
--	----------------	--

Les Lames indépendantes

	<p>Lame rigide Kato</p>	<p>Chez Karin</p>
	<p>Lame souple Kato</p>	<p>Chez Karin</p>
	<p>La petite Lame pour Canes Kato</p>	<p>On pleure : Elle n'existe plus Remplaçable par la lame Kemper (cfr plus bas)</p>
	<p>La grosse lame de rechange Lucyclay 20 cm de long rigide</p>	<p>Perles and co Lucyclay</p>

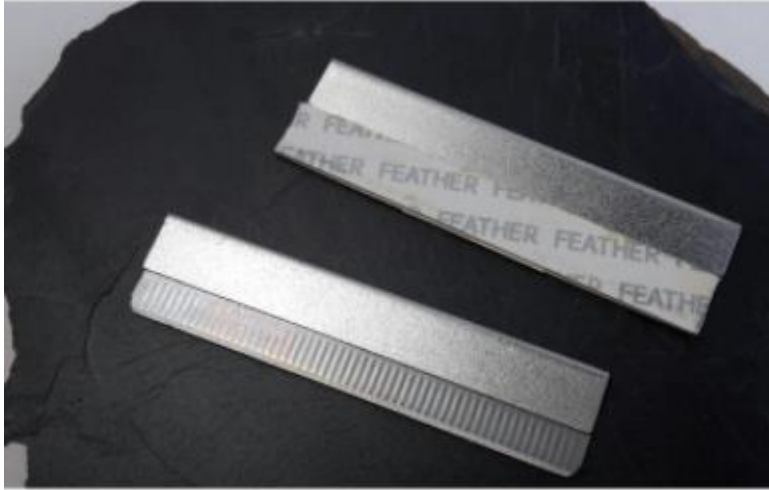

La mini lame de
Jan Montarsi



La lame courte
Kemper

Chez Karin ☺

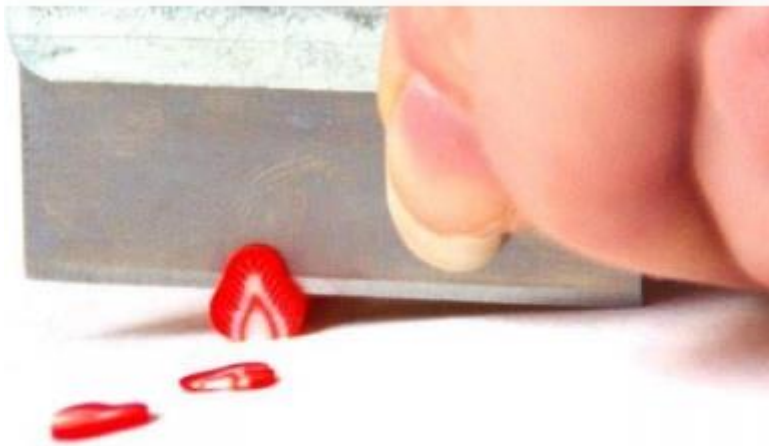

Lame
gourmandises
« La petite
épicerie »

	<p>La lame –scalpel « au doigt » de Fiskars</p>	 <p>Chez Karin</p>
	<p>Lame Rotative 360 degrés Fiskars</p>	<p>Chez Karin</p>

Les lames ondulées

<p>Pas toute seule</p>	<p>Chez Fimo</p>	
<p>Pas toute seule</p>	<p>Chez Sculp ey</p>	

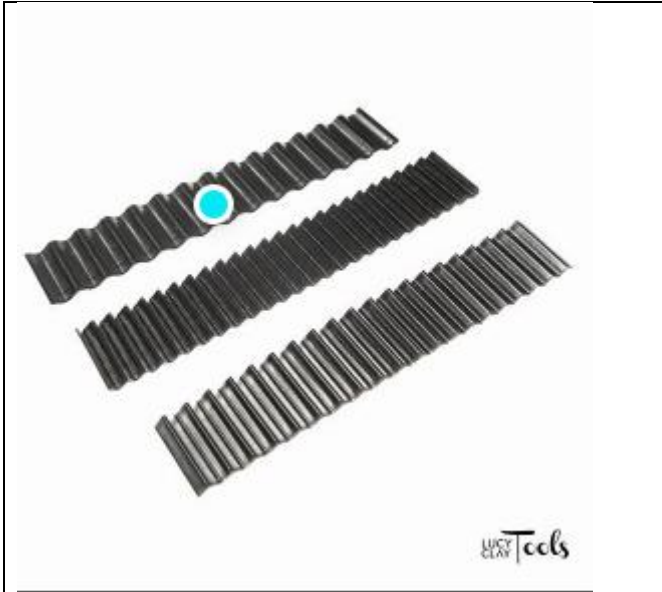

Chez
Lucy
Clay

On
pleur
e !

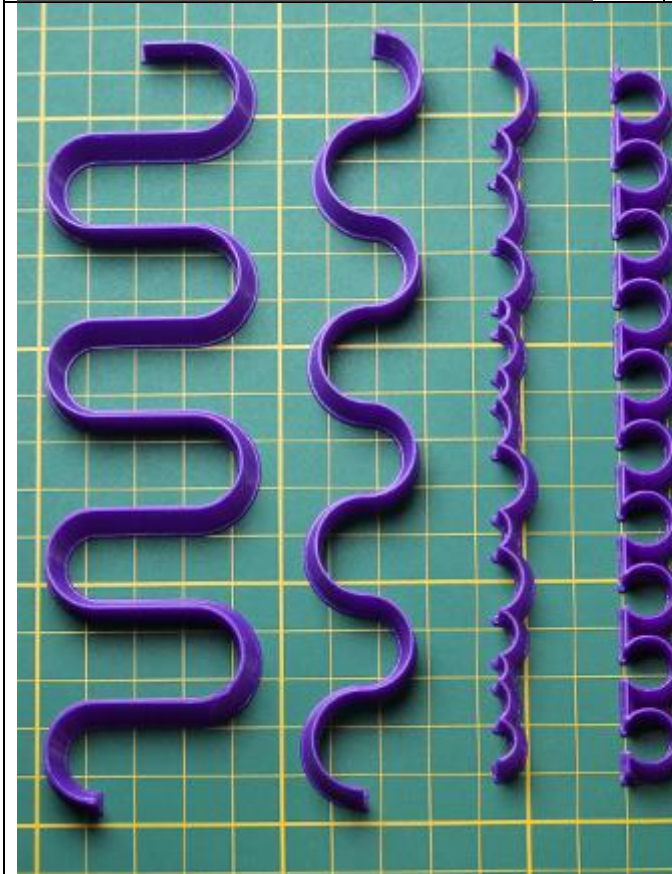
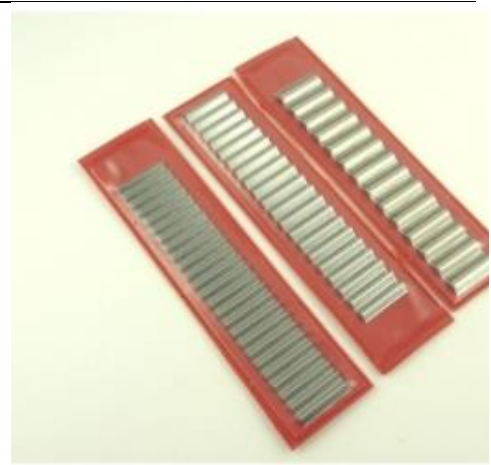

En « gabarits » chez FunnyPat

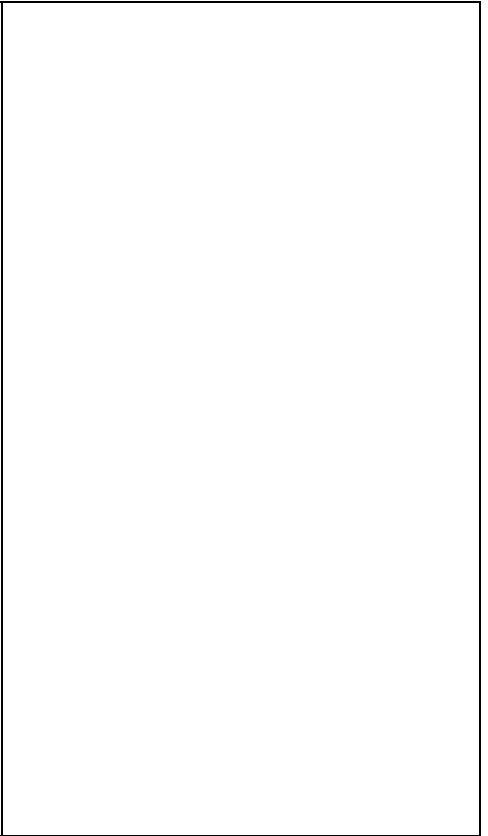
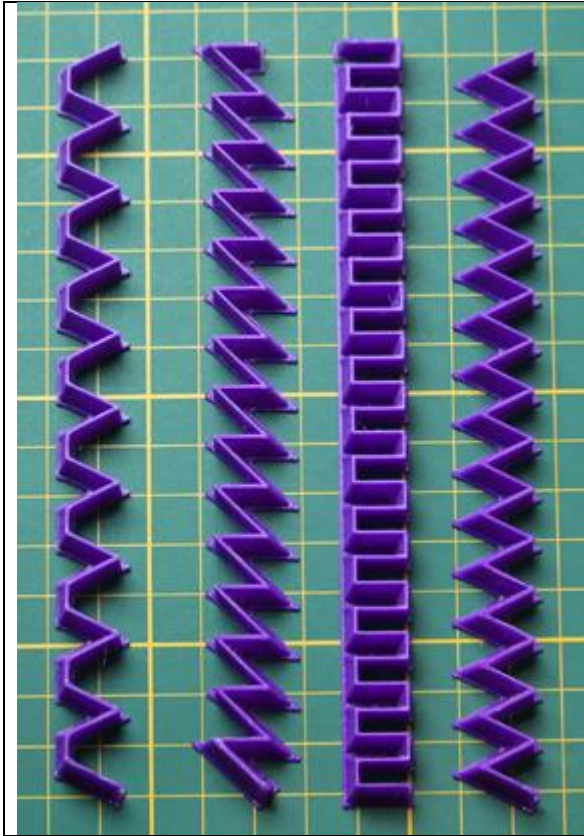

L'usage des lames ondulées



Carol Blackburn